

**VEMAVENTURI**  
A PERI COMPANY

# ISC LINK

---

Concrete Pressure Monitoring  
Concrete Temperature Monitoring

---

User Guide v1.1

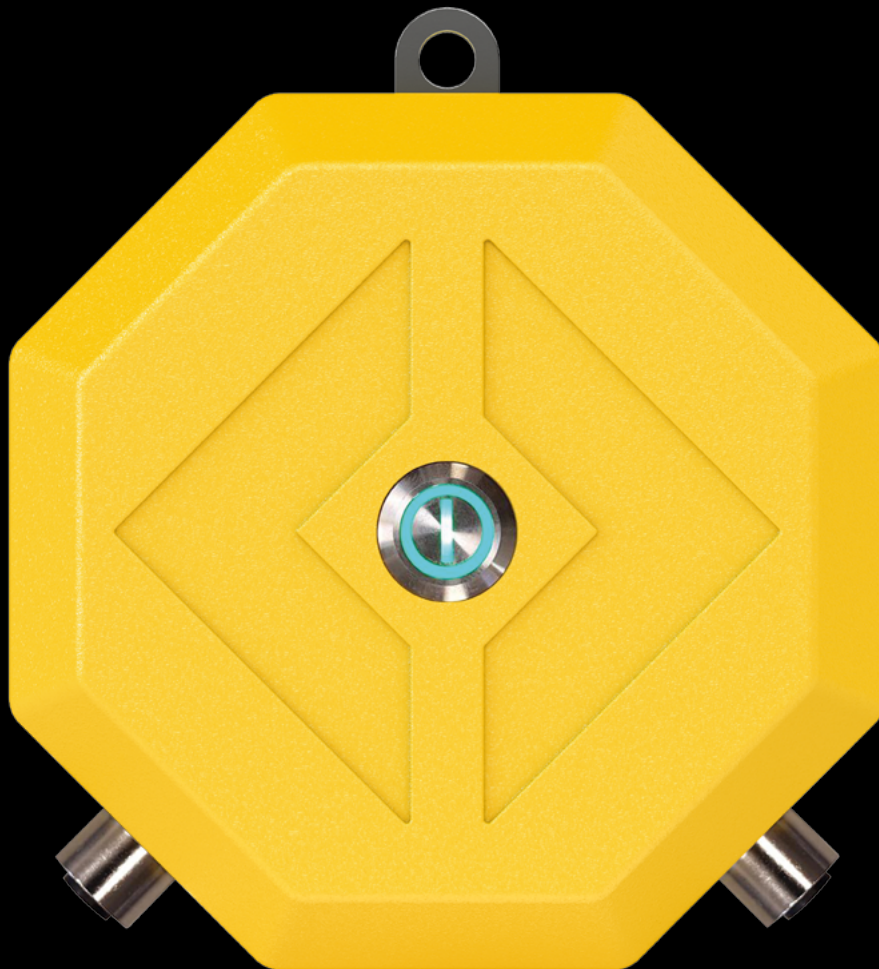

# Language

---



English 4 – 22

# Content

---

<b>1</b>	<b>Overview</b>	<b>4</b>
----------	-----------------	----------

<b>2</b>	<b>Introduction</b>	<b>5</b>
----------	---------------------	----------

2.1.	Intended use	5
2.2.	Instructions on use	5
2.3.	Target groups	5

<b>3</b>	<b>Safety Instructions</b>	<b>6</b>
----------	----------------------------	----------

3.1.	Warnings	6
3.2.	General information	6

<b>4</b>	<b>Application</b>	<b>8</b>
----------	--------------------	----------

4.1.	Connect device to a Project	8
------	-----------------------------	---

<b>5</b>	<b>Connectivity and Upload Process</b>	<b>9</b>
----------	--	----------

<b>6</b>	<b>LED Indications</b>	<b>10</b>
----------	------------------------	-----------

<b>7</b>	<b>Recycling and Disposal</b>	<b>11</b>
----------	-------------------------------	-----------

7.1.	Disposal	11
------	----------	----

<b>8</b>	<b>System Peripherals</b>	<b>12</b>
----------	---------------------------	-----------

<b>9</b>	<b>Concrete Pressure Monitoring</b>	<b>13</b>
----------	-------------------------------------	-----------

9.1.	Technical details	13
9.2.	Fitting and connecting the pressure sensor	14
9.3.	Deinstallation	16
9.4.	Troubleshooting	16
9.5.	Maintenance	17

<b>10</b>	<b>Concrete Temperature and Maturity Monitoring</b>	<b>20</b>
-----------	---	-----------

10.1.	Technical details	20
10.2.	Installation	20
10.3.	Calibration for Concrete Maturity Monitoring	21

<b>11</b>	<b>Manufacturing Information</b>	<b>22</b>
-----------	----------------------------------	-----------

# 1 Overview

---

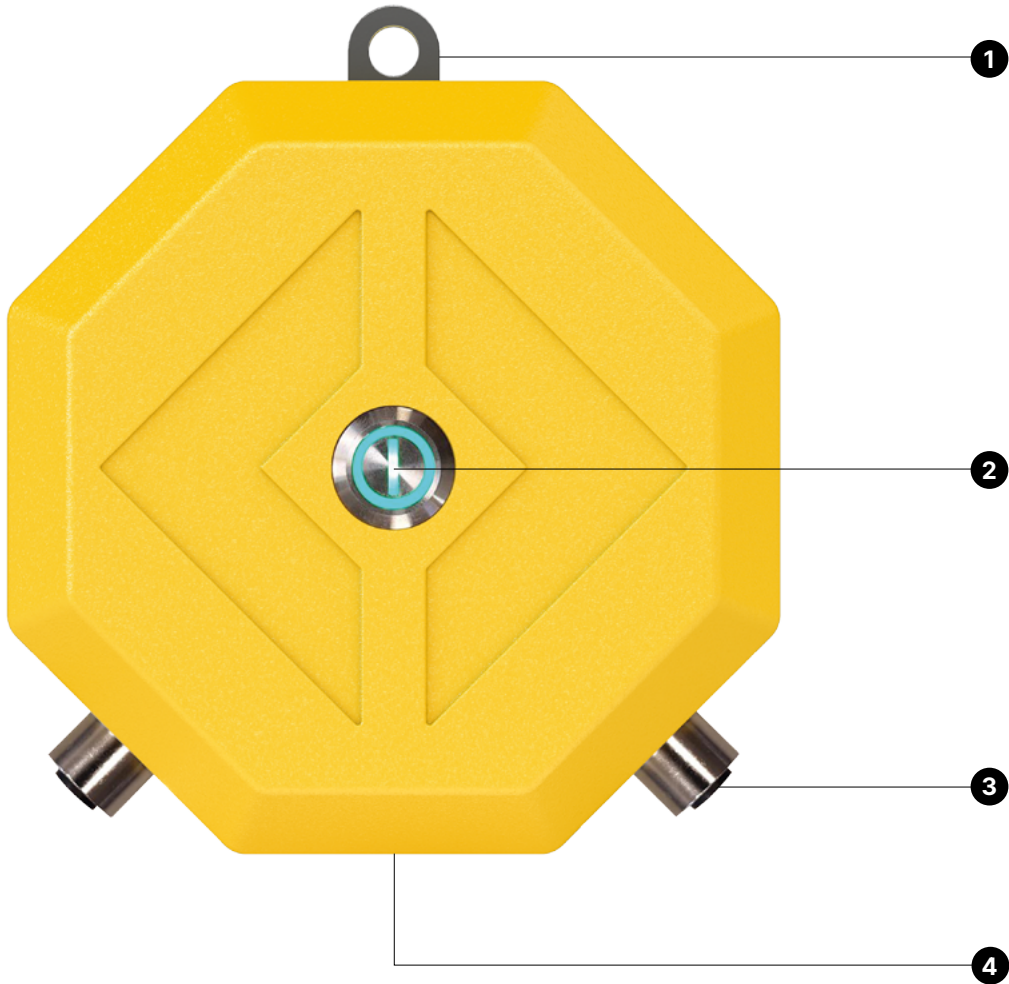

1. Hanging bracket
2. ON/OFF button with status LED
3. Measuring channels
4. USB-C for charging and data transfer

# 2 Introduction

## 2.1. Intended use

Vemaventuri products are designed solely for use in the industrial and commercial sectors by trained personnel.

Only use the product for its specified purpose, while strictly adhering to the provided technical data.

Any use outside the intended purpose is not allowed.

The function and operational safety of the product can only be guaranteed if the generally applicable safety precautions, national regulations, and the specific safety instructions in these Instructions for Use are followed.

The product is intended for measuring purposes as defined and outlined in the technical data. Only the instructions described in the Instructions for Use constitute proper use of the product.

The information regarding the intended use of the system must be observed.

## 2.2. Instructions on use

Usage that deviates from the intended use as outlined in the Instructions for Assembly and Use constitutes a misapplication with potential safety risks.

Changes to Vemaventuri components are not permitted.

Only original Vemaventuri parts may be used. The use of non-Vemaventuri products or spare parts constitutes misapplication with associated safety risks.

## 2.3. Target groups

### Contractors

Contractors working in industrial or commercial environments, particularly those involved in concrete placement, monitoring, or quality control tasks.

### Concrete testing laboratories

Laboratories performing quality testing or evaluating curing conditions using measurement and monitoring equipment.

### Quality assurance and site engineers

Personnel responsible for monitoring concrete performance, compliance, and curing conditions on construction sites.

### Concrete suppliers

Personnel involved in the delivery and handling of fresh concrete, particularly when verifying mix conditions or supporting production control.

### Construction site coordinator

The Safety and Health Protection Coordinator is appointed by the client and must:

- Identify potential hazards during the planning phase.
- Determine measures to mitigate risks.
- Create a health and safety plan.
- Coordinate protective measures for contractors and personnel, ensuring they do not endanger each other.
- Monitor compliance with safety measures.

### Competent personnel

Competent personnel must possess specialist knowledge gained from professional training, work experience, and recent professional activity, allowing them to understand safety-related issues and carry out inspections properly. Depending on the complexity of the task, varying levels of specialist knowledge may be required.



In other countries, ensure compliance with relevant national guidelines and regulations. If no country-specific regulations are available, it is recommended to follow German guidelines and regulations.

### Qualified persons

Vemaventuri products may only be used by personnel who are suitably qualified. These qualified individuals must receive instructions covering at least the following points:

- An understandable explanation of the assembly or dismantling plan for the Vemaventuri product.
- A description of the safety measures for assembling or dismantling the Vemaventuri product.
- Details on safety precautions for changing weather conditions that may impact the product's safety or the personnel.
- Information on permissible loads.

# 3 Safety Instructions

## 3.1. Warnings

Warnings appear before instructions for action and are categorised as follows:



### Danger

means that serious bodily injury or death will occur if the aforementioned precautions are not taken.



### Warning

means that serious bodily injury or death may occur if the aforementioned precautions are not taken.



### Caution

means that minor bodily injury may occur if the aforementioned precautions are not taken.



means that damage to property or an undesirable situation may occur if the aforementioned precautions are not taken.

## 3.2. General information



### Warning

**If the equipment is used in a manner not specified by the manufacturer or this document, the protection provided by the equipment may be impaired.**



### Warning

**The unit is only for indoor charging with the power adapter and is powered by an internal battery inside the unit when operated in outside environment.**



### Warning

**Do not leave the unit exposed to direct sunlight for an extended period of time.**



Safety instructions apply to all service life phases of the system.

The contractor must ensure that the installation and operating instructions provided are available at all times and understood by the site personnel.

### 3.2.1. Before using the system

- Read and understand this manual and the safety instructions it contains carefully.

- Observe the laws and regulations in force in the country of use. This includes, in particular, safety precautions as required when handling live equipment.
- Check units, mains cables and accessories for damage and functional correctness.
- Damaged connectors and cables must be removed immediately and no longer used.
- Only use original spare parts from the manufacturer.

Failure to observe these safety precautions may result in injury or damage to the unit.

The unit has been designed for use in harsh environments. Operations outside of the specified conditions may result in damage to the equipment.

### 3.2.2. Charging the unit



### Danger

**Lithium-ion battery is installed in the unit. The battery may only be replaced by a qualified person!**

The usage time or the discharge speed of a battery depends on several factors:

- Ambient temperature
- Usage time
- Temperature log rate
- Battery age

If the battery capacity and discharge time have decreased significantly, the battery should be replaced. To do this, contact a service workshop designated by the manufacturer.

**Never replace the batteries yourself.**

If the unit is left unused, the battery will discharge over approximately three months. After being stored without charge for this period, the unit may be unresponsive for up to 10 minutes when first connected to power. To maintain battery health, the unit should be charged at least every six months, even when not in use.

The lithium-ion batteries must be charged **before the units are used for the first time**. The battery charging circuitry in the ISC Link ensures that the batteries do not overheat or get damaged during the charging process.

# 3 Safety Instructions

## 3.2.3. Charging the ISC Link



### Danger

When charging the unit, only use the charger specified by the manufacturer or a comparable voltage source. A deviation in the charging voltage can result in damage to the device.

The device heats up during the charging process. If the ISC Link only functions briefly or not at all despite repeated charging, the built-in battery is defective and must be replaced.

## 3.2.4. Temperatures and ambient conditions

ISC Link has been designed for use in harsh environments. Operations outside of the specified conditions may result in damage to the equipment.

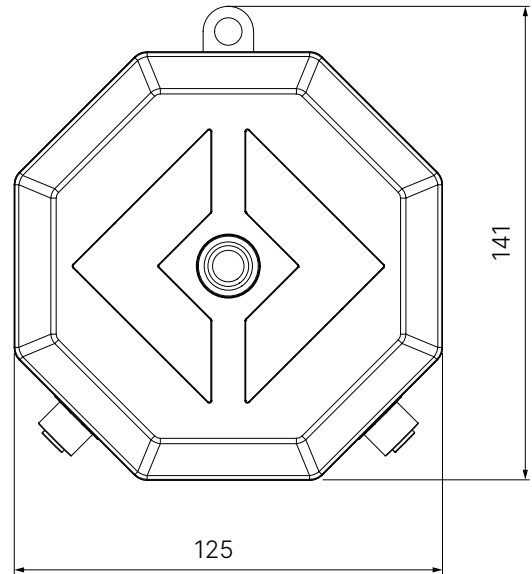

Electrical characteristics	
Input	5 V DC max, 3 A
Rated capacity	Up to 17.28 Wh
Rated Voltage	3,6 VDC
Number of cells	1
Interface	1x USB-C

Ambient conditions	
Operating temperature (discharging)	-20 to 45 °C (-4 to 113°F)
Ambient temperature when charging the battery	5 to 40 °C (41 to 104 °F)
Transport temperature	15 to 25 °C (59 to 77 °F)
Storage temperature	15 to 25 °C (59 to 77 °F)
Ambient humidity	90 % rH non-condensing

Housing material	Plastic
Protection type	IP66 (EN 60529) *
Weight	0,4 kg
Over voltage category	OVC I
Degree of pollution	3
Usage	indoor and outdoor up to 2000 m a.s.l.

Can also be used in wet locations  
 Definition of wet locations:  
 The environment in which water or another conductive liquid may be present and in which it is likely that the resistance of the human body will be reduced by wetting of the contact between the human body and the device and by wetting of the contact between the human body and its environment.

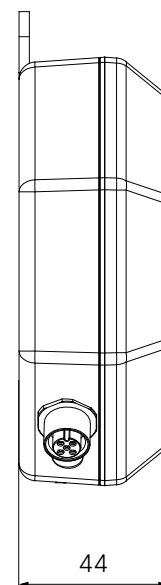

Figure 1: Measurements are displayed in millimeters

# 4 Application

**ISC Link** is a compact and easy-to-use tool for monitoring concrete pressure, temperature and maturity. The ISC Link can be connected to PREMO pressure sensors or digital temperature sensors. ISC Link records temperature or pressure data during the curing process and uploads it to Vemaventuris WebApp. This real-time data helps you track the curing progress and make informed, data-driven decisions. Its simple design minimizes setup time and maintenance, ensuring a smooth monitoring experience for your construction projects.

## 4.1. Connect device to a Project

The ISC Link must be connected to a project before it can be used. Connecting to a project ensures the user has physical access to the device and the necessary permissions to associate it with a project.

### Steps to connect a ISC Link

1. Turn on ISC Link by pressing and holding the ON/ OFF button for three seconds.
2. Device establishes a cloud connection after booting.
3. Follow the appropriate scenario:

#### Scenario 1:

##### Device not previously connected to a project

1. Device LED blinks green.
2. Scan the QR code on the backside of the device.
3. Log in to or create an account on <https://insite.peri.app/>
4. Follow the instructions on screen to be guided through the connection process.

#### Scenario 2:

##### Device previously connected to a project

1. Press the ON/OFF button three times to enter connection mode.
2. Follow the process from scenario 1.

### 4.1.1. Updating ISC Link

To initiate an update to the device:

1. Go to the device overview on [https://insite.peri.app](https://insite.peri.app/)
2. Select the device
3. Click the "update device" button

If an update is available, the device will: Upload all stored data. Automatically install the update.

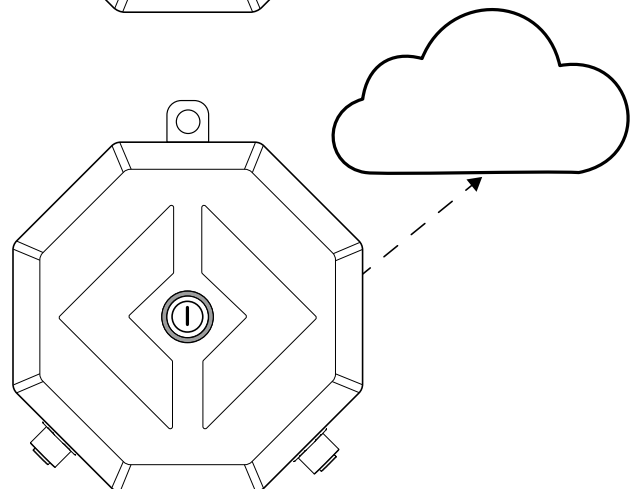
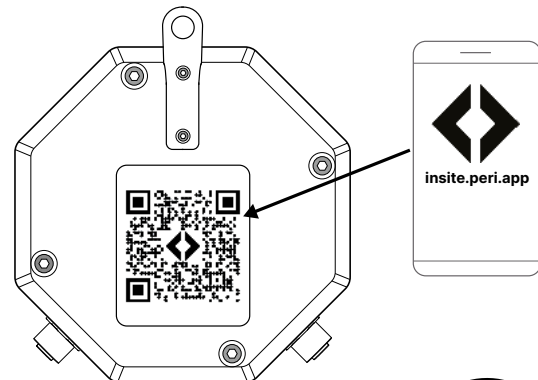
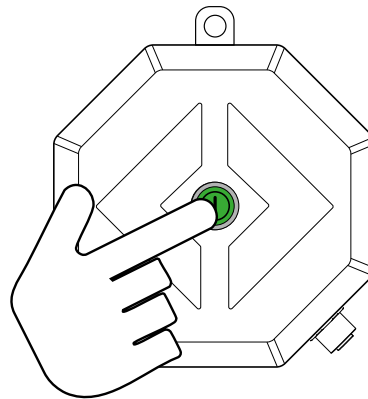

# 5 Connectivity and Upload Process

---

The device connects to the Cloud via LTE to upload data.

- It wakes up every 15 minutes to log a temperature measurement.
- It attempts to upload these logged measurements every hour.

If Cloud connection fails:

- The device will continue logging locally.
- To save battery, it will not keep trying to connect.
- Instead, it will wait 12 hours (rounded down) before trying again.







If you press the button to force-synchronize the device





- The device will try to connect for up to 5 minutes.
- If this fails, it will wait 12 hours before trying again (unless another force connect is triggered).
- If the upload is successful, the device will return to the 1-hour upload schedule.

This behavior prevents unnecessary battery drain during Cloud outages or poor coverage (e.g. in tunnels).

# 6 LED Indications

The device uses a single button with an LED indicator to show its status. The table below explains what the unit is doing.

LED Behaviour		Event
	steady green	Device is powered on and connected to a project
	Flashing green	Device is in connection mode and is waiting to connect to a project
	Pulsing green	Charger is connected and unit is charging, When fully charged LED will be steady green
	Flashing green	New firmware is being downloaded (after initiated on the WebApp)
	Flashing red	Firmware update has failed
	No light	Device is in sleep mode Device is powered off (press button once to see if it wakes up or is powered off)

Action	LED Behaviour	Event
Press and hold button (When device is powered <b>OFF</b> )		Light fades up green Device is powered ON, connects to cloud
Press button once		Light turns on briefly, then off again Wakes device from sleep, force connects to cloud and uploads data
Press 3 times quickly (When device is powered <b>ON</b> )		Flashing green Device enters connection mode and can be connected to a project
Press and hold button (When device is powered <b>ON</b> )		Light fades down green Device is powered OFF

# 7 Recycling and Disposal

---

## 7.1. Disposal



The units must be disposed of and recycled in accordance with local environmental protection regulations.

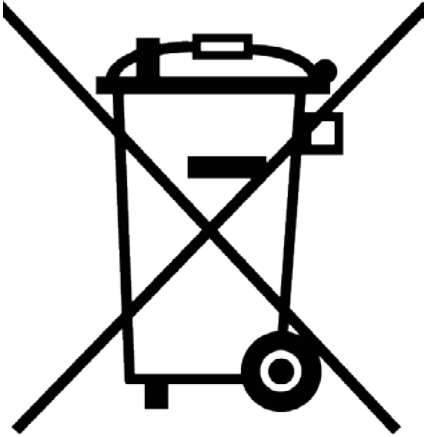

# 8 System Peripherals

---

ISC Link supports two types of sensors:  
**temperature** and **pressure**.

You can connect up to 2 temperature sensors  
(one per channel).

You can connect up to 8 pressure sensors,  
with a maximum of 4 per channel.

Each channel (CH-A and CH-B) supports either:

- 1 temperature sensor
- 1 to 4 pressure sensors

# 9 Concrete Pressure Monitoring

## 9.1. Technical details

Properties		
Pressure transducer	Type	DPS 5000
	Power supply	2.7 ... 3.6 V DC, 2 mA
	Working pressure	0 ... 2 bar (0 ... 200 kPa)
	Precision	± 0.1 % FS (full scale)
	Output signal	I2C digital

Ambient conditions		
	Operating temperature	-15 ... +55°C (5 ... 131°F)
	Ambient humidity	L 95 % rF non-condensing

Interfaces, communication I2C digital		
PERI bus	Serial interface	1 × 5-pin socket, digital, semiproprietary
	Protocol	I <sup>2</sup> C

Unit structure		
	Material, housing	Stainless steel
	Membrane filling	Glycerol
	Protection type	IP68
	Weight	0.86 kg

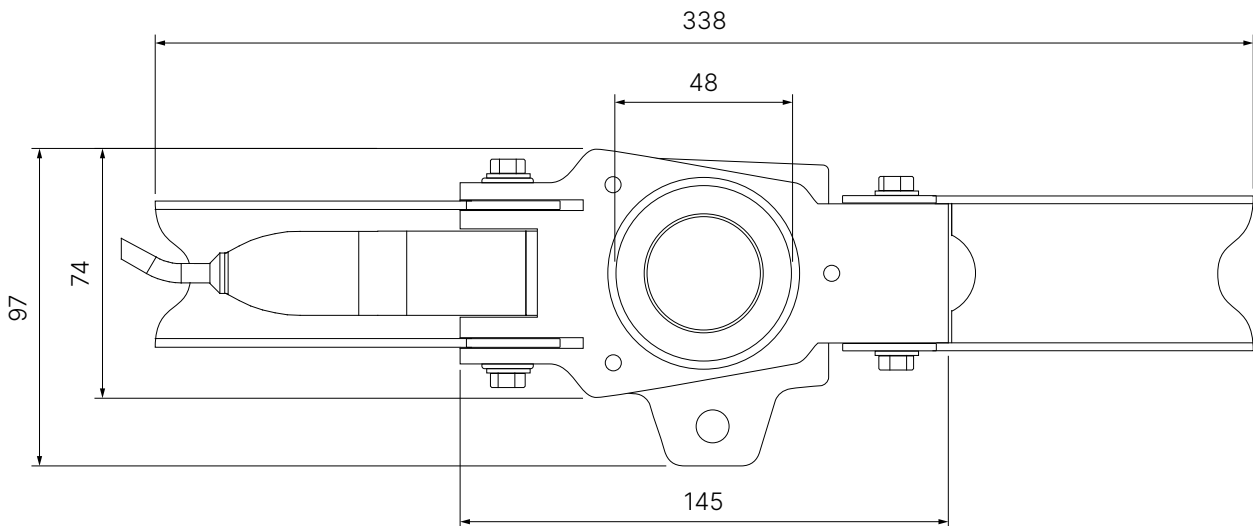

We provide PREMOSensor pressure sensors in sizes of 21 mm and 42 mm to accommodate different plywood thicknesses, and spacers are available for intermediate dimensions.

Figure 1:  
Dimensions of PREMOSensor  
Measurements are displayed in millimeters

# 9 Concrete Pressure Monitoring

## 9.2. Fitting and connecting the pressure sensor

### 9.2.1. Preparation

- Determine and mark the positions of the sensors.
  - The distance between the sensors should be approx. 1.5 m for an 8-m-high wall.
  - Position the sensors in the lower part of the formwork.
  - An additional series of sensors will increase the accuracy.
- Check the sensor cable, connector, housing and membrane for damage and ensure that the filling is free of bubbles.
- Have a drill with a 50 mm hole saw and centre drill, (drilling template (only for PREMO DUO) screws and grease (e.g. Vaseline) to hand.

### 9.2.2. Installing the sensor group

#### 9.2.2.1. PREMO Sensor

1. Drill the hole for the sensor into the formwork using the hole saw. – Make sure that there is enough space for the sensor housing.
2. Grease the membrane and housing (recommendation: Vaseline).
3. Place the sensor on the formwork and pre-drill the holes for the screws.
4. Tighten the sensor with 3 screws. (Figure 1)



Figure 1

5. Affix the ISC Link safely and securely near the measuring points.
6. Connect the sensors to the PERI bus connection of the ISC Link and to each other using XLR-cables and splitters as needed. (Figure 2)
7. Switch on the ISC Link.  
The measured data from the sensor is received automatically.
8. Document the ISC Link number and position or installation heights of the pressure sensor in the formwork.

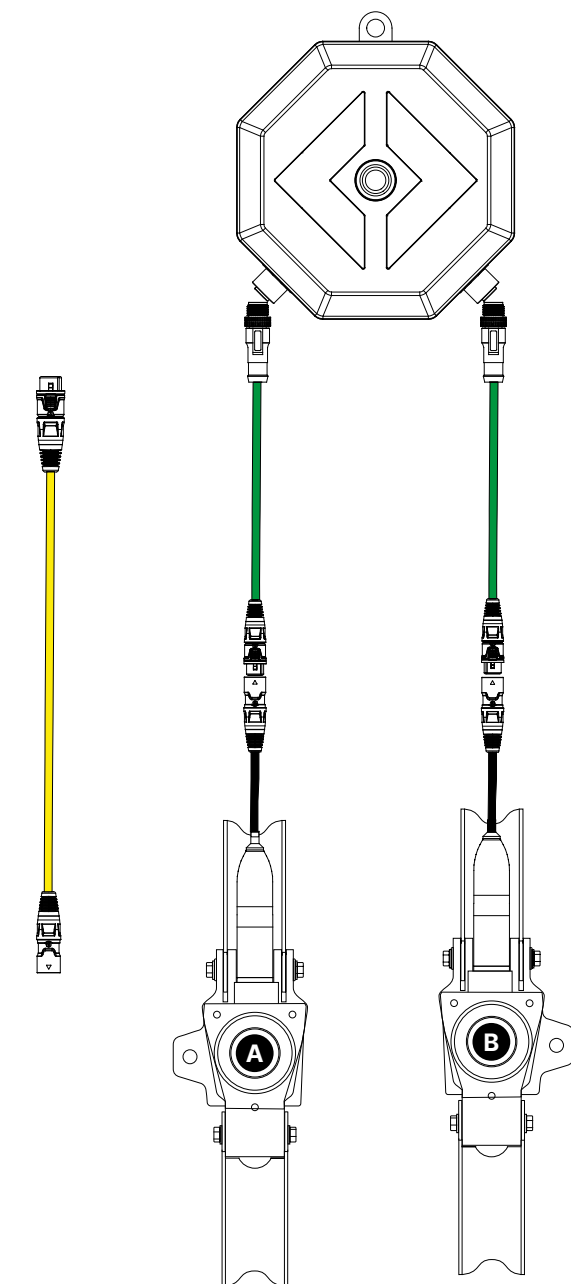

Figure 2

# 9 Concrete Pressure Monitoring

## 9.2.2.2. PREMO DUO Sensor

1. Determine and mark the positions of the sensors.
  - The distance between the sensors should be approx. 1.5 m for an 8-m-high wall.
  - Position the sensors in the lower part of the formwork.
  - An additional series of sensors will increase the accuracy.
2. Fix the drilling template to the DUO formwork. (Figure 3)  
Drill the hole for the sensor into the formwork using the hole saw.
3. Grease the membrane and housing (recommendation: Vaseline).
4. Place the sensor on the formwork and tighten the sensor with 2 screws at the top and bottom. (Figure 4)
5. Install the protective cover and secure it with two screws on the right and left sides (Figure 3).
6. Affix the ISC Link safely and securely near the measuring points.
7. Connect the sensors to the PERI bus connection of the ISC Link and to each other using XLR-cables and splitters as needed. (Figure 5)
8. Switch on the ISC Link.  
The measured data from the sensor is received automatically.
9. Document the node number and position or installation heights of the pressure sensor in the formwork.



Figure 3

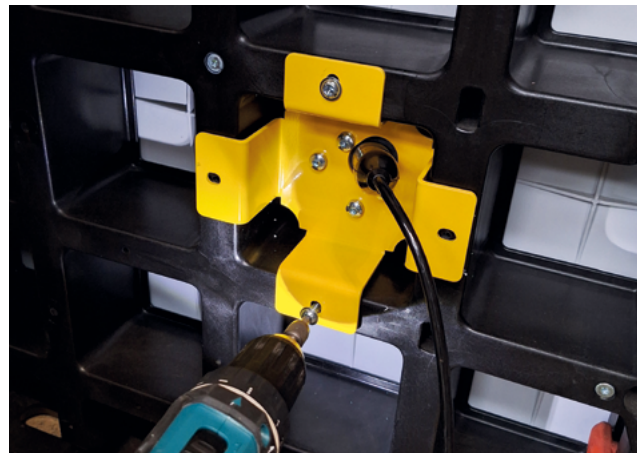

Figure 4



Figure 5

# 9 Concrete Pressure Monitoring

---

## 9.2.3. Checking the functional integrity

Check the functional integrity and data transmission before concreting.

By pressing the black button on the node a force connect and upload is initiated, indicated by all LEDs flashing orange and then blue. The Hub's Pressure screen displays the status and readings of the connected sensors. You can check there whether all the measured data is being received correctly.

The current pressure is displayed in kilopascals (kPa).  
1 kPa = 0.01 bar.

## 9.3. Deinstallation

1. Disconnect the bus cable connector from the ISC Link and pressure sensor.
2. Disconnect the connecting cables between the sensors.
3. Unscrew the sensors from the formwork.
4. Clean the housing and membrane.
  - Do not use pointed or sharp objects.

## 9.4. Troubleshooting

Possible causes of unsuccessful measuring:

- No pressure sensor connected
- Defective connecting cable
- Pressure sensor damaged (pressure transducer or leaky membrane)
- Node not switched on or low battery

# 9 Concrete Pressure Monitoring

## 9.5. Maintenance

### 9.5.1. Replacing the membrane

1. Cleaning cloth
2. Syringe without needle (approx. 20 ml)
3. Screwdriver (TORX T15)
4. TORX bit T10
5. Glycerol
6. Base plate
7. Membrane
8. Screw ring with O-ring

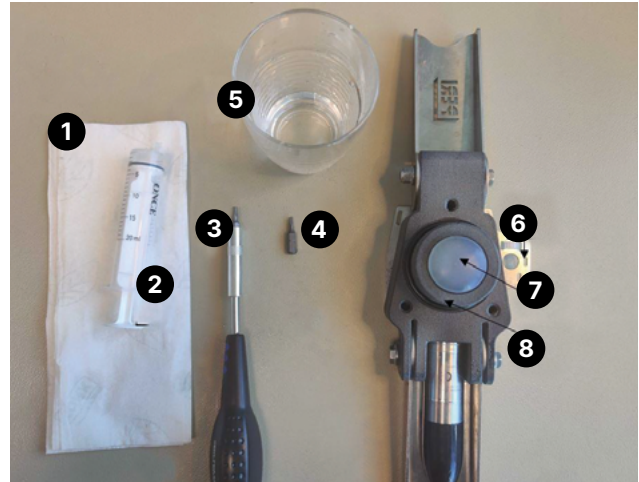

### Instructions

1. Unscrew the base plate.
2. Carefully clean the inside and outside of the housing if it's dirty.
3. Unscrew the bleed screws.
4. If the membrane is not ruptured, pour the glycerol through the vent holes into a container.
5. Press on the undamaged membrane to squeeze out the remaining liquid through the vent holes. The glycerol can be reused if it is clear and free of dirt particles.
6. Unscrew the screw ring counterclockwise by hand. Using a damp cloth may improve your grip.

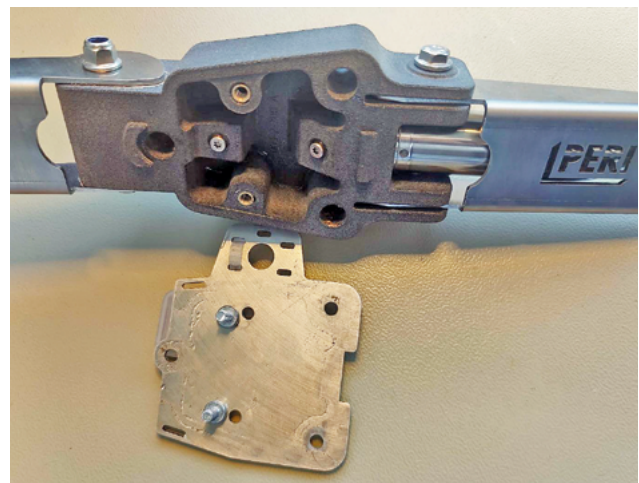

# 9 Concrete Pressure Monitoring

7. Remove the damaged or old membrane from the screw ring.
8. Clean the screw ring.
9. Insert the new membran



10. Replace the O-ring if it is worn or damaged.
11. Wipe the threads in the screw ring and on the sensor housing until dry. This will make it easier to spot any leaks later on.
12. Screw the screw ring onto the sensor housing and tighten it by hand.



13. Fill the syringe with glycerol. When drawing up the syringe, do not allow air bubbles to form.
14. Keep the sensor housing horizontal and insert the syringe into the vent hole (hole closest to the pressure transducer).
15. Pour glycerol into the housing until it emerges at the vent hole.



# 9 Concrete Pressure Monitoring

16. Remove the syringe and close the opening with a bleed screw. Leave the second vent hole open.
17. Tilt the sensor housing by approximately 45 degrees so that the open vent hole is at the top and the pressure transducer is at the bottom.
18. Carefully press on the membrane with your finger until liquid can be seen in the vent hole. Keep the pressure on the membrane.



19. Remove the syringe and close the opening with a bleed screw.
20. Turn the unit with the membrane facing upwards and hold it horizontally.
21. Repeat steps 17 to 21 if air bubbles are visible beneath the membrane.
22. Carefully wipe the housing and the bleed screw until they are dry.
23. Press on the membrane for several seconds with the heel of your hand, using only a little force. Check the housing for leaks.

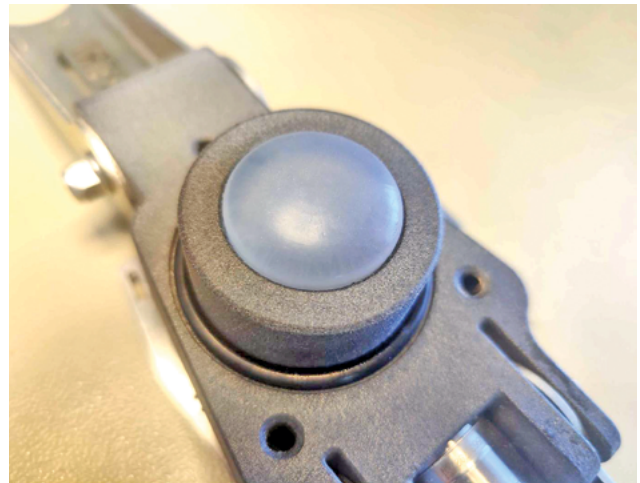

You can find more information in the video of the membrane replacement.

# 10 Concrete Temperature and Maturity Monitoring

## 10.1. Technical details

Ambient conditions	
Operating temperature	-10 °C to +120 °C (14 °F to 248 °F)
Accuracy	±0.5 °C (±0.9 °F)

Unit structure	
Sensor size	6 mm diameter by 35 mm long
Sensor cable length	5 m
Connection	PERI Bus

## 10.2 Installation

Each channel (CH-A and CH-B) on the ISC Link supports one temperature sensor. (Figure 1)  
To install and connect a temperature sensor, follow these steps:

1. Plug the connector of the temperature sensor into CH-A or CH-B on the ISC Link.
2. Place the measuring tip at the desired measurement location.
3. Secure the sensor in position, for example by attaching it to the rebar using cable ties. (Figure 2)



Figure 1: Digital Thermocouple



Figure 2: Digital Thermocouple mounted

# 10 Concrete Temperature and Maturity Monitoring

## 10.3 Calibration for Concrete Maturity Monitoring

This section describes the end-to-end procedure to calibrate a concrete mix for maturity-based, real-time strength estimation. Follow these steps before using in-place maturity results to make decisions such as striking formwork, removing cold-weather protection, or opening to traffic. Requirements and actions below align with common industry practice (e.g., ASTM C 1074, DIN EN 12390-2) for specimen preparation and curing.

### 1. Preparation:

Plan for a minimum duration of 28 days or until the design strength is reached. Use the same concrete mix intended for the structure and prepare between five and fifteen cubes or cylinders according to your local standards. Label each specimen with its casting date. Install a Vemaventuri temperature sensor, in the center of at least one specimen, ideally the last one scheduled for crushing. Cure all specimens according to local standards, such as a 20 °C water bath in compliance with DIN EN 12390-2.

### 2. Crushing Schedule and Data Capture:

Carry out compressive strength tests at 1, 2, 3, 7, and 28 days. If early decisions are anticipated, include additional intervals during the first few days. For each specimen, record the exact crushing time and the measured compressive strength in megapascals. Increasing the number of specimens improves the

accuracy of the calibration curve by reducing variance. If speed is critical, plan additional early-age tests to refine the strength trajectory for early decision-making.

### 3. Create the Concrete Calibration:

In the WebApp navigate to Menu → Concrete → Concrete Calibration and select “Create New Concrete Calibration.” Enter the required details, including basic information, concrete data, and the temperature channels linked to the embedded sensor.

### 4. Maturity-Strength Calibration Output:

Once all data is entered, the WebApp will generate a maturity–strength curve based on recognized methods such as Saul or Arrhenius, as referenced in e.g. ASTM C1074. This curve enables estimation of in-place strength using sensor temperature data collected on site. (Figure 3)

#### 10.3.1. Quality and Safety Considerations

Maintain a complete calibration log that includes specimen identifiers, casting dates, curing conditions, crushing timestamps, strength results, and linked sensor channels. This documentation supports audits and compliance. While the calibration process aligns with DIN EN 12390-2 and ASTM C1074, correct application and interpretation remain the responsibility of the user. Always review local codes and project specifications before relying on maturity results for structural decisions.

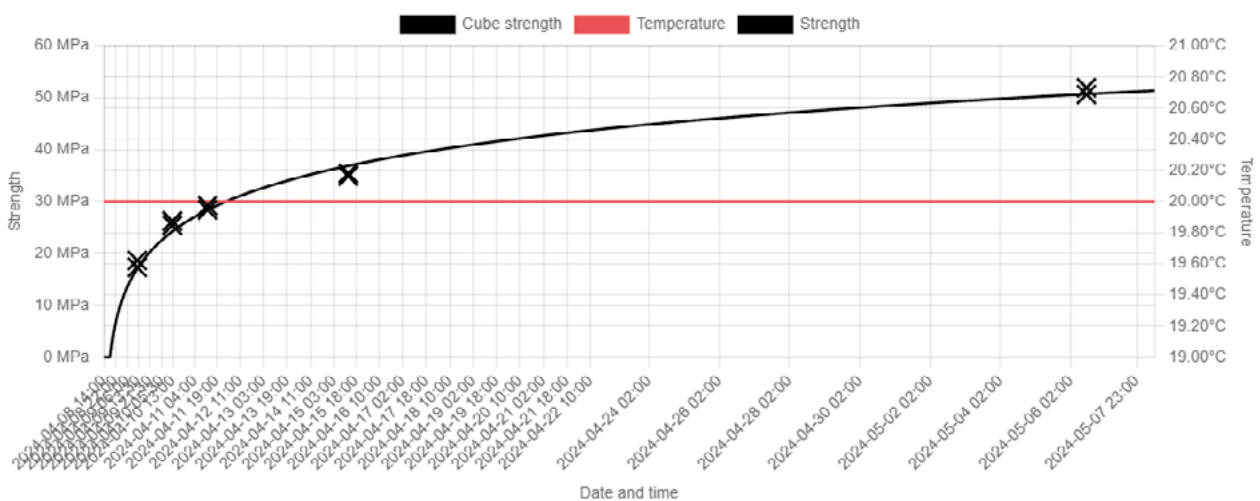

Figure 3: Calibration

# 11 Manufacturing Information

---

**Designed and manufactured by**

Vemaventuri AB  
Doktorandgatan 10A  
431 44 Mölndal  
Sweden

**Assembled at**

BEPE Elektronik AB  
Borgens gata 8A  
441 39 Alingsås



---

**Vemaventuri AB**

Doktorandgatan 10A  
431 44 Mölndal  
Sweden

**Vemaventuri GmbH**

Rudolf-Diesel-Staße 19  
89264 Weißenhorn  
Germany

Phone: +49 7309 950 2244

Email: [info@vemaventuri.io](mailto:info@vemaventuri.io)

Website: [vemaventuri.io](http://vemaventuri.io)



**VEMAVENTURI**  
A PERI COMPANY